



## SL2

**SLEEVE LETTER PLATE**

To suit Doors 35-65mm Thick

**Dimensions (mm):**      **GA**  
 Overall:                      292x64  
 Aperture:                    255x38

**Finishes:**

**SL1**                              **SA**  
**SL3**                              **PCW**  
**SL4**    **PCB \*SPECIAL ORDER**



## ML110921/24/28

**PRO STYLE LETTERBOX**

To suit Doors 40-80mm Thick

**Dimensions (mm):**  
 Overall:                      310x76  
 Aperture:                    264x46



## AA79

**SUNK SLIDE FLUSH BOLT**

**Dimensions (mm):**  
 Overall:                      102x17  
 Shoot Diameter:            8

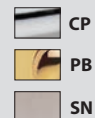



AA813

**FLUSH BOLT SOCKET**

13mm Slot Size

**Dimensions (mm):**

Overall: 64x20



CP



PB



SN



**AQ46**  
WOOD



**AQ47**  
CONCRETE

AQ46

**DUST EXCLUDING SOCKET FOR FLUSH BOLTS** Wood

**Dimensions (mm):** CP/PB

Circular section: 45 Dia.

Hole Size: 12

**AQ47** Concrete

**Dimensions (mm):** CP/PB/SC

Circular section: 25 Dia.

Hole Size: 12



CP



PB



SC



Aluminium version also available

BR35

**BATHROOM INDICATOR BOLT**

**Dimensions (mm):**

Overall: 64x38



CP



PB





AA34

**SECURITY BOLT WITH TURN****Dimensions (mm):**

Fixing Plate: 57x20



AA35

**INDICATOR BOLT WITH EMERGENCY RELEASE****Dimensions (mm):**

Fixing Plate: 57x20

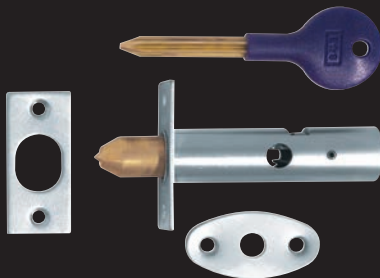

DSB8225

**SECURITY DOOR BOLT****Dimensions (mm):**

Length: 60

Backset: 32

**Variations:****DSB8225L**

Length: 85

Backset: 57

**DSK8000** Key

B



**DB8**

**DUTCH DOOR BOLT**

c/w 3 Keeps for Various Applications

**Dimensions (mm):**

Length: 202

**Variations:**

**DB12** 305

**DB18** 457

**DB24** 610



CP



PB



SC

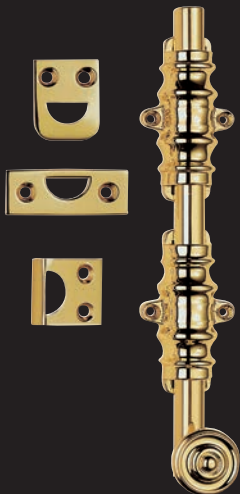

**OD8**

**ARCHITECTURAL  
SURFACE BOLT**

c/w 3 Keeps for Various Applications

**Dimensions (mm):**

Length: 202

**Variations:**

**OD12** 305

**Finish: PB**

**OD18** 457

**OD24** 610



CP



PB

**AQ82EX****SURFACE BOLT**

c/w 3 Keeps for Various Applications

**Dimensions (mm):**

Extended Bolt: 150  
Overall Length: 355

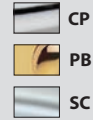
**AQ82****SURFACE BOLT**

c/w 3 Keeps for Various Applications

**Dimensions (mm):**

Overall: 150x35

**Variations:**

**AQ81** 102x35

**Finishes:**

**CP/PB/SC**

**AQ83** 202x35

**AQ84** 254x35

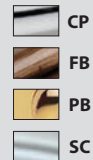

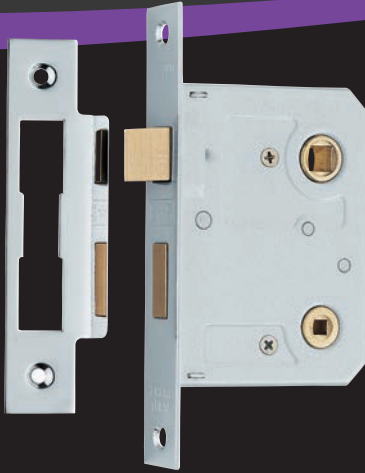

**BL4**

**BATHROOM LOCK**

**Finish:** NP  
**Dimensions (mm):**  
 Nickel Plate Forend: 76

**Variations:**  
**BL2**  
 Nickel Plate Forend: 64

**Finishes:** EB/FB  
**BL1**  
 Electro Brass Forend: 64  
**BL3**  
 Electro Brass Forend: 76

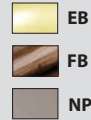

**CL155SGVCB**

**MECHANICAL DIGITAL DOOR LOCK**

**Dimensions (mm):**  
 Latch: 60

CL155SGVCB only available  
 in pre-pack





TL1-4 EB and NP finishes also available in Radius  
 TL1 = TLE8025EB/R  
 TL2 = TLE8025NP/R  
 TL3 = TLE8030EB/R  
 TL4 = TLE8030NP/R

## TL4

### TUBULAR LATCH

Rebate Set TL7A Available

**Finish:** NP

**Dimensions (mm):**

Nickel Plate Forend: 76

**Variations:**

TL2 Tubular Mortice Latch: 64

STL2 Super Latch Extra Spring: 64

STL4 Super Latch Extra Spring: 76

**Finishes:** EB/FB/PCB

TL1 Electro Brass Forend: 64

TL3 Electro Brass Forend: 76

**Finishes:** EB

STL1 Super Latch Extra Spring: 64

STL3 Super Latch Extra Spring: 76

 EB

 FB

 NP

 PCB

(B)

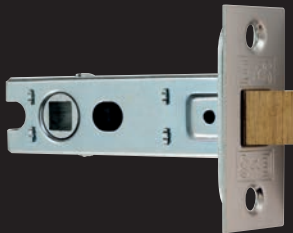

c/w radius and square face plates

## BTL1

### BOLT THROUGH TUBULAR LATCH

**Finish:** EB

**Dimensions (mm):**

Electro Brass Forend: 64

**Variations:**

**BTL3**

Electro Brass Forend: 76

**Finish:** NP

**BTL2**

Nickel Plate Forend: 64

**BTL4**

Nickel Plate Forend: 76

 EB

 NP

(B)



ART5005 Rebate set  
available  
38mm Bolt through  
centres on DL5030-50

**DL5030**

**DELAMAIN HEAVY  
SPRUNG TUBULAR LATCH**

**Dimensions (mm):**

Overall Length:	76
Backset:	57

**Variations:**

**DL5025**



Overall Length:	64
Backset:	45

**DL5040**

Overall Length:	103
Backset:	82

**DL5050**

Overall Length:	128
Backset:	107

-  **FB**
-  **PB**
-  **SS**

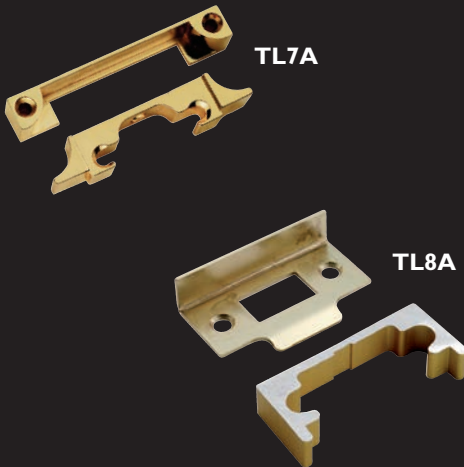

**TL7A REBATE SET**

To Suit Tubular Latches

**Dimensions (mm):**

Strike:	13x22
Length:	92

**TL8A SUPER REBATE SET**

To Suit Tubular Latches

**Dimensions (mm):**

Strike:	13x25
Length:	57

**TL9A REBATE SET**

To Suit Tubular Latches

**Dimensions (mm):**

Strike:	13x22
Length:	92

-  **EB**
-  **NP**







38mm Bolt through  
centres

### DLD5030

#### DEAD BOLT

##### Dimensions (mm):

Overall Length:	76
Backset:	57

##### Variations:

#### DLD5040

Overall Length:	103
Backset:	82

#### DLD5050

Overall Length:	128
Backset:	107



FB



PB



SS



### AA45

#### CONCEALED CHAIN SPRING DOOR CLOSER

FIRE TEST CERTIFICATE  
BS476:PART 22:1987

##### Dimensions (mm):

Forend:	45
---------	----

##### Variations:

AA45R	Radius
-------	--------



CP



PB



SC







**AA46**

**EASI-KEEP LATCH**  
FIRE TEST CERTIFICATE  
BS476:PART 22:1987

**Dimensions (mm):**

Overall Size: 63x40  
Depth: 10

-  CP
-  EB
-  PCW

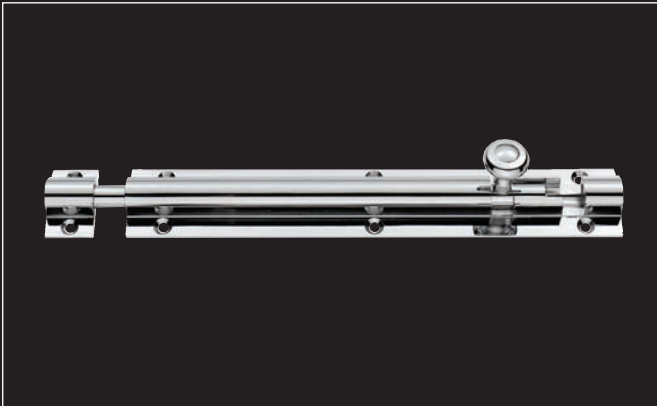

**BB3208**

**BARREL BOLT**





**Dimensions (mm):**

8"x32

**Variations:**

- BB3204** 4"x32
- BB3206** 6"x32
- BB3806** 6"x38
- BB3808** 8"x38
- BB3810** 10"x38
- BB3812** 12"x38
- BB4512** 12"x45
- BB4518** 18"x45

-  CP
-  PB
-  SC





**DK45**

**GRAVITY DOOR CATCH**

**Dimensions (mm):**

Backplate: 30x50

-  CP
-  PB
-  SC