



FTD815 Double Ball Catch

CODE **L x W x H**

CODE	L x W x H
FTD815A	43x8
FTD815B	50x9.3
FTD815C	60x11.5
FTD815D	70x13.5



 **AB**  **SC**  **SCOL**



FTD840/850 Superior Steel Magnetic Catch

CODE **L x W x H**

CODE	L x W x H	
FTD840	46x15x14	6.0Kg pull
FTD850	46x15x14	3.5Kg pull

 **EB**  **FB**  **NP**



FTD835 Deluxe Nylon Magnetic Catch

CODE **L x W x H**

CODE	L x W x H	
FTD835A	42x14x14	4.5Kg pull
FTD835B	56x14x14	6.0Kg pull

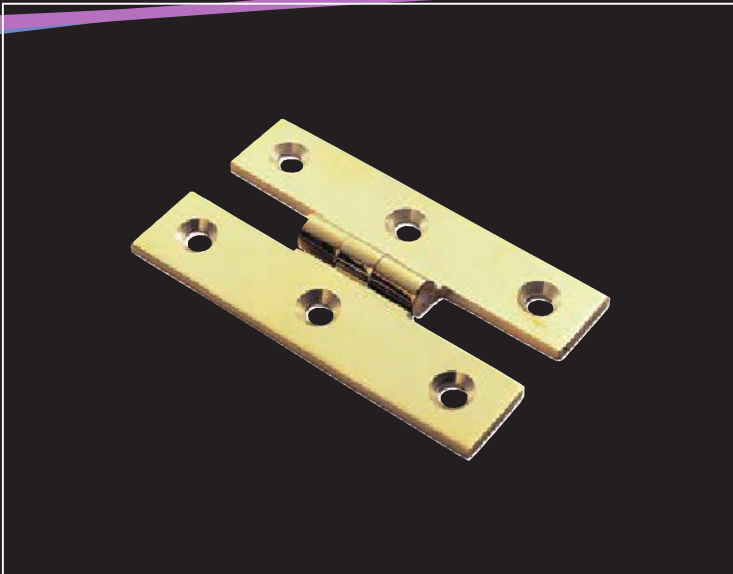

 **NBR**  **NWH**



FTD810 Brass H Pattern Hinge

CODE	L x W x H
------	-----------

FTD810	63x38x2.5
--------	-----------

 AB
  POL/LAC





FTD805 Finial Cabinet Hinge

CODE	L x W x H
------	-----------

FTD805C	50x28x1.5
---------	-----------

FTD805D	64x35x2
---------	---------

Add 6mm to either end for finial ends.

 AB
  PB
  SC







FTD800 Cabinet Hinge

CODE	L x W x H
------	-----------

FTD800C	50x28x1.5
---------	-----------

FTD800D	64x35x2
---------	---------

 AB
  CP
  PB

 SC
  SCOL



FTD855 Heavy Pattern Cable Tidy

CODE	Insert	TTI
FTD855	62 dia.	20

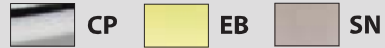

FTD435 Semi Circular Backplate

CODE	
FTD435	112x55

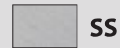

WF13 T - Handle Fastener

CODE		Slotted T
WF13	57x19	23





H4.100.35 Soft Close Hinge

CODE

- H4.100.35.30 Inset Soft Close Hinge
- H4.100.35.20 Half Overlay Soft Close Hinge
- H4.100.35.10 Full Overlay Soft Close Hinge

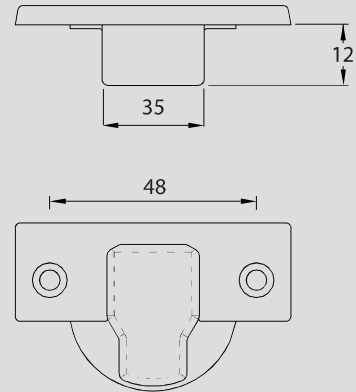

For hinge fitting guide see P68.

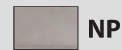

P4.100.35 Mounting Plate

CODE

- P4.100.35.00 0mm Mounting Plate
- P4.100.35.02 2mm Mounting Plate
- P4.100.35.A00 0mm Adjustable Plate

Standard Plate
Euroscrew 14x6mm
Included

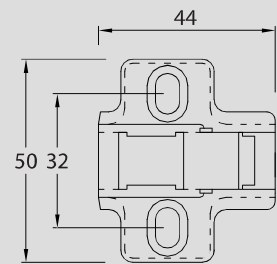

Adjustable Plate
Screws Not
Included

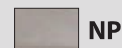
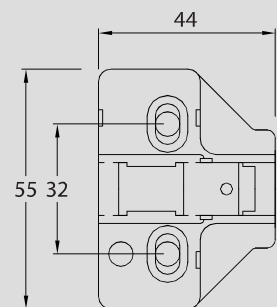

Fitting Procedure

Clamp the hinge to the plate shown as direction arrow in diagram (a).

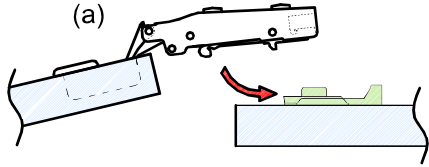

Press down the hinge arm to lock the plate as shown as direction arrow in diagram (b) assembling complete.

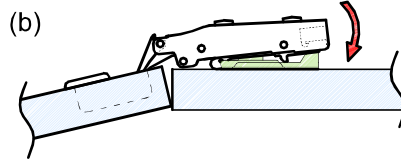

Disassembling shown as diagram (c) by pushing the clip button.

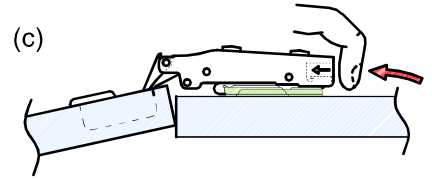

Overlay Calculations for Plate Selection

Inset
 $H=4.5+K+A$

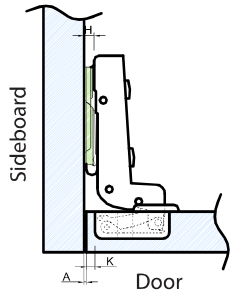

Reveal Calculations

$\begin{matrix} A \\ \diagdown \\ H \\ \diagup \\ K \end{matrix}$	3	4	5	6
0	1.5	0.5	-0.5	-1.5
2	3.5	2.5	1.5	0.5
4	5.5	4.5	3.5	2.5

Half Overlay
 $H=5+K-D$

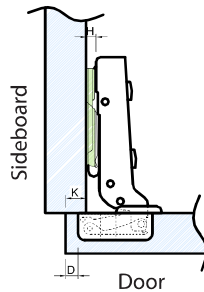

Overlay Calculations

$\begin{matrix} D \\ \diagdown \\ H \\ \diagup \\ K \end{matrix}$	3	4	5	6
0	17	18	19	20
2	15	16	17	18
4	13	14	15	16

Full Overlay
 $H=14+K-D$

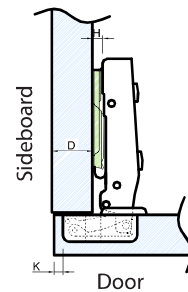

Overlay Calculations

$\begin{matrix} D \\ \diagdown \\ H \\ \diagup \\ K \end{matrix}$	3	4	5	6
0	8	9	10	11
2	6	7	8	9
4	4	5	6	7

Adjustment Range

Height Adjustment

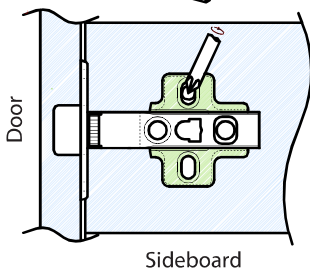
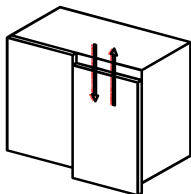

Depth Adjustment

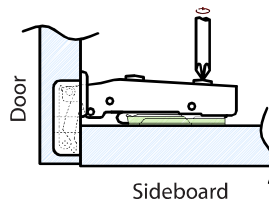
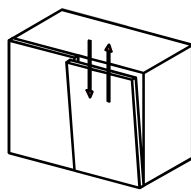

Side Adjustment

